

# ASSEMBLY INSTRUCTIONS

WAC1230

Step 1

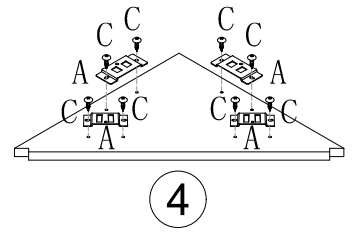
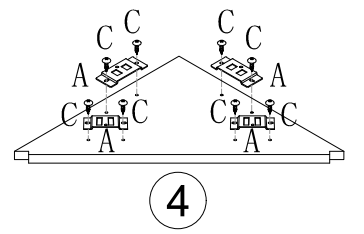
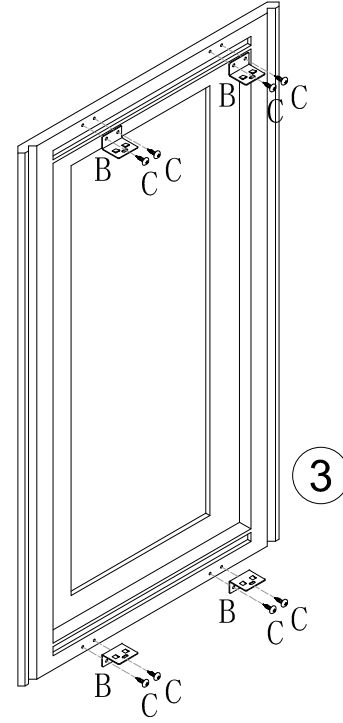
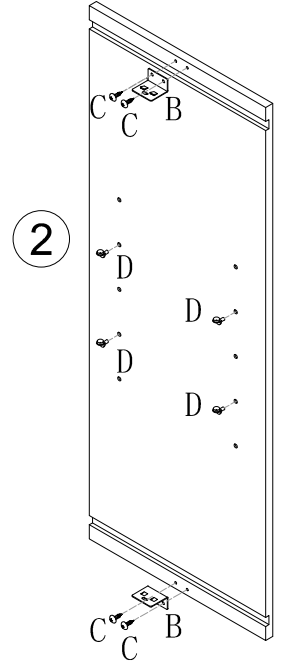
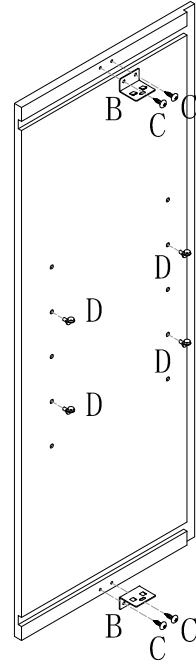
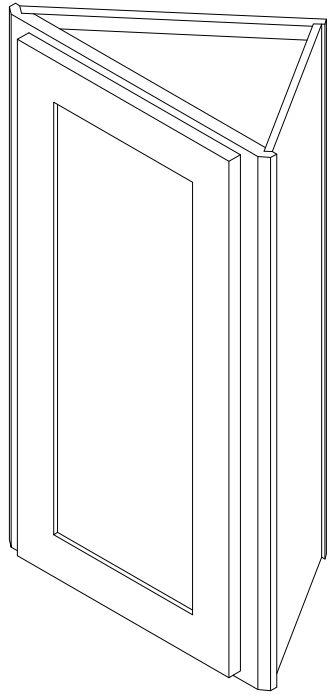

## Parts list

NO.	Parts	QTY
A		8
B		8
C	 (M4*0.47")	40
D		8

Tools  
(required but not provided)

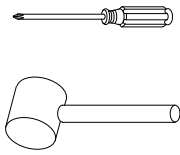

Step 2

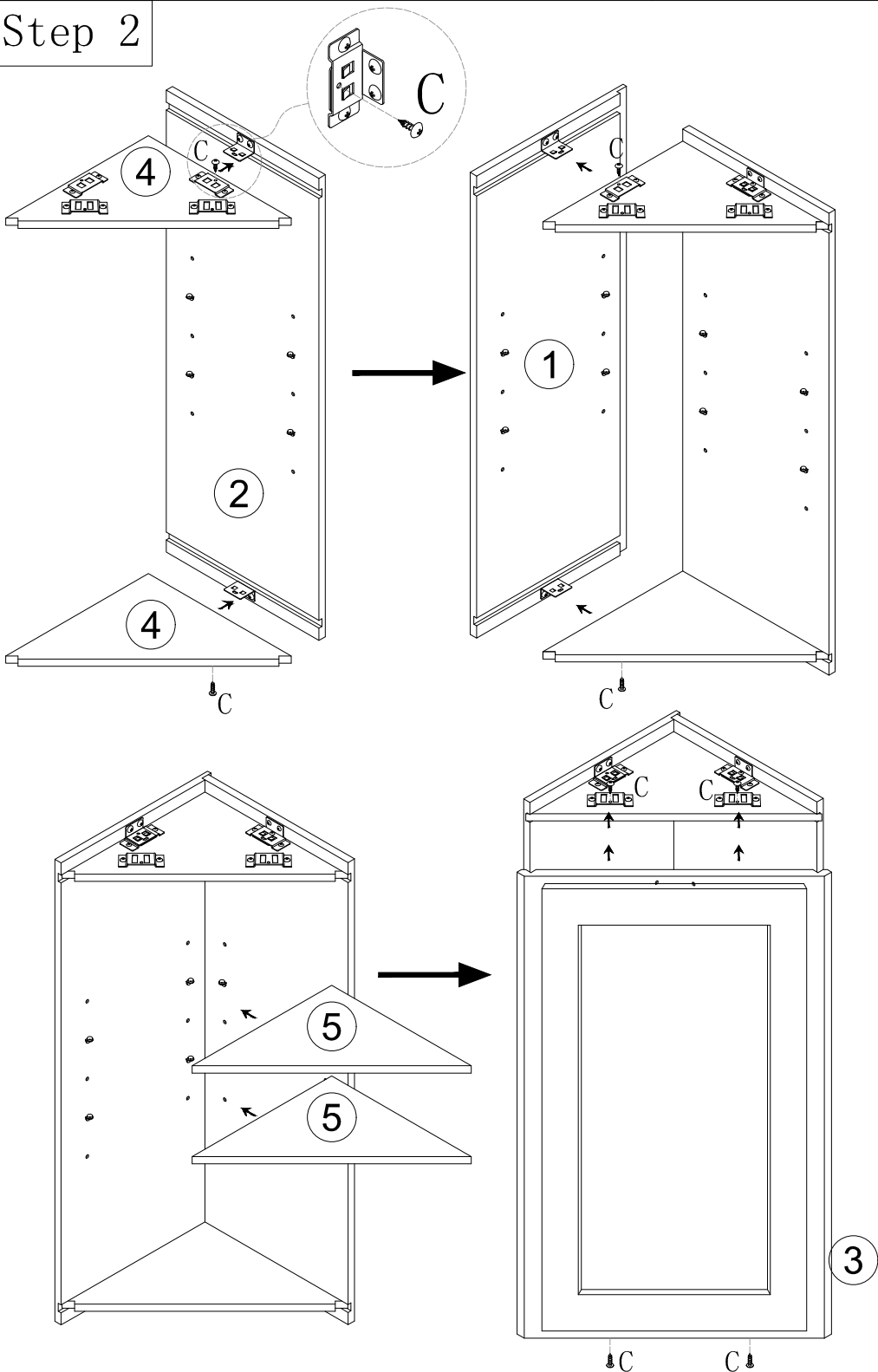

Finished

